



NÁUTICA PEDRO FRANCO, S.L.

Polígono Industrial de Águilas | 30880 ÁGUILAS (Murcia) España

(+34) 968412030

www.NauticaPedroFranco.com



¡Construimos hoy para responder siempre!

> Marine crane **cafran**

INOX
Stainless Steel



GIA-40/2

Maximum hydraulic outreach 6,30 m. - 600 Kg.

Stainless Hydraulic Crane. Full turn on base. Articulated and telescopic arms.
Lower loads in vertical, ready to install Capstan. Ideal for hanging halador and other appliances.
Danfoss control of progressive control and speed with the same power, arms, winch, halador or others.



Proportional Command



Group turn with brake



Brass valves



Hydraulic installation

Load diagram

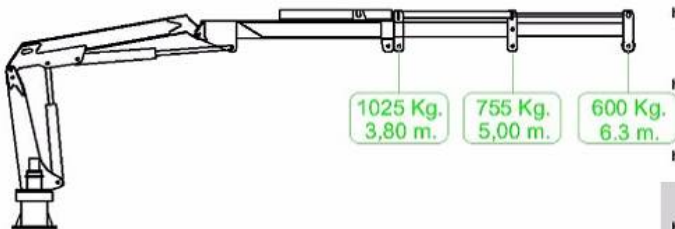

Manufacturing Range

- GIA22/1 (2,1 Tn. m.)
hydraulic outreach 4,25 m. - 520 kg.
- GIA22/2 (2,1 Tn. m.)
hydraulic outreach 5,50 m. - 380 kg.
- GIA40/1 (3,9 Tn. m.)
hydraulic outreach 5,00 m. - 780 kg.
- GIA40/2 (3,9 Tn. m.)
hydraulic outreach 6,30 m. - 600 kg.
- GIA65/1 (6,5 Tn. m.)
hydraulic outreach 6,00 m. - 1190 kg.
- GIA65/2 (6,5 Tn. m.)
hydraulic outreach 7,60 m. - 900 kg.

Caractéristiques Techniques

Maximum lifting capacity	39 kNm
Maximum hydraulic outreach	6,3 m
Par Gross slewing torque	930 kgm
Slewing angle	360°
Maximum working pressure	220 bar
Maximum oil flow	25 l/min
Mass	802 kg

Dimensions

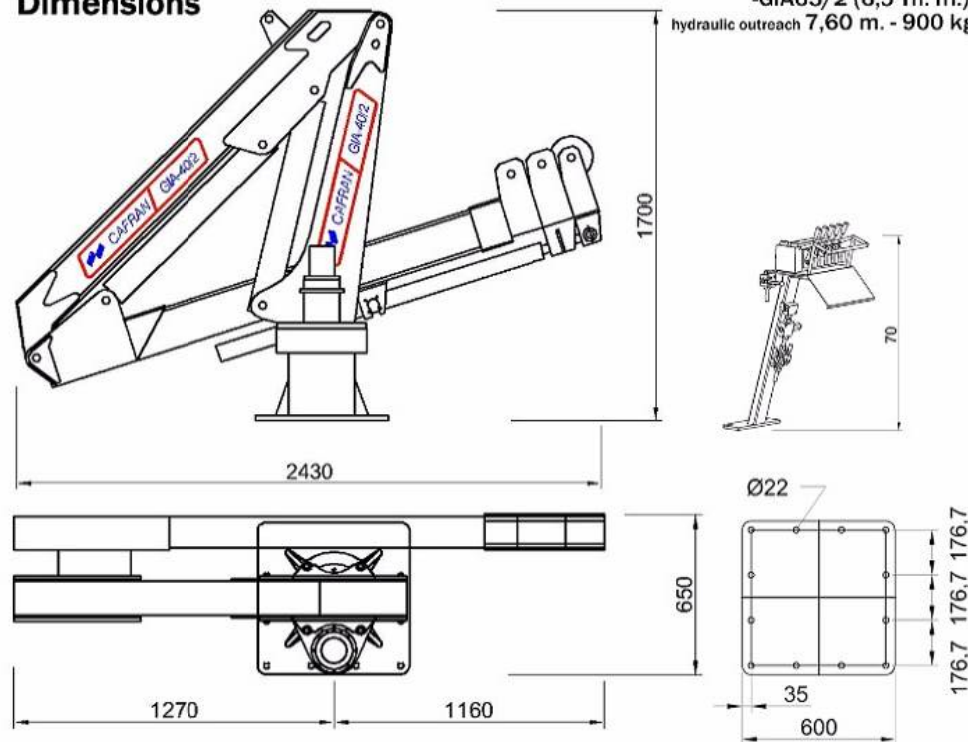

Positions diagram

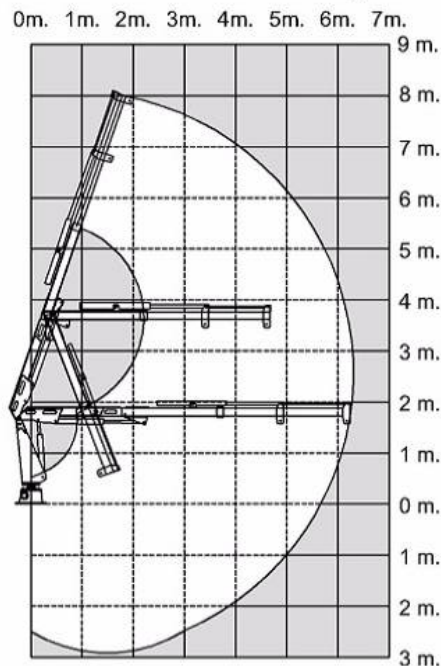

Series equipment

- Stainless Steel construction.
- Anti-corrosion finished in the cabin.
- Spinning by epicolic group with brake, drag by hardened pinion and crown. Axis of rotation over bearing in oil bath.
- Cylinders with Ni-Cr stems for marine environments.

- Bronze valves Anti-abrasion hoses.
- Safety valves piloted in the cylinders.
- Emergency stop and hydraulic load limiter.
- Stainless pipe and fittings.
- Danfoss Proportional Distributor.

Optional equipment

1: Hydraulic winch



2: Auxiliary hydraulic intakes (power block...)



3: Remote control



4: Joint installations with machines



5: Manual Prolongation



6: Stainless base for lifting crane



7: Electric, diesel or gasoline HPU

